

**GB**

**JUICE EXTRACTOR**  
INSTRUCTION AND MAINTENANCE MANUAL

**ES500**

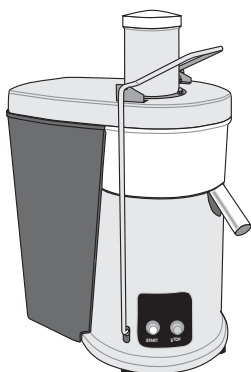

**ES500S**

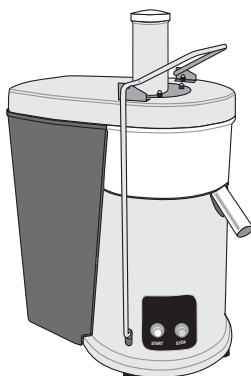

**ES700**

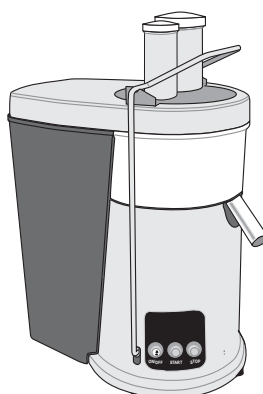

## JUICE EXTRACTOR

### Main parts (Fig. 1 - Fig. 2)

- |          |                |           |                     |
|----------|----------------|-----------|---------------------|
| <b>1</b> | Motor housing  | <b>9</b>  | Basket              |
| <b>2</b> | Bowl           | <b>10</b> | Pulp retainer       |
| <b>3</b> | Spout          | <b>11</b> | Grating disc        |
| <b>4</b> | Juicer cover   | <b>12</b> | Switch ON-OFF (I-O) |
| <b>5</b> | Locking arm    | <b>13</b> | START button        |
| <b>6</b> | Food pusher    | <b>14</b> | STOP button         |
| <b>7</b> | Feed chute     | <b>15</b> | Motor shaft         |
| <b>8</b> | Pulp container | <b>16</b> | Drive disc          |

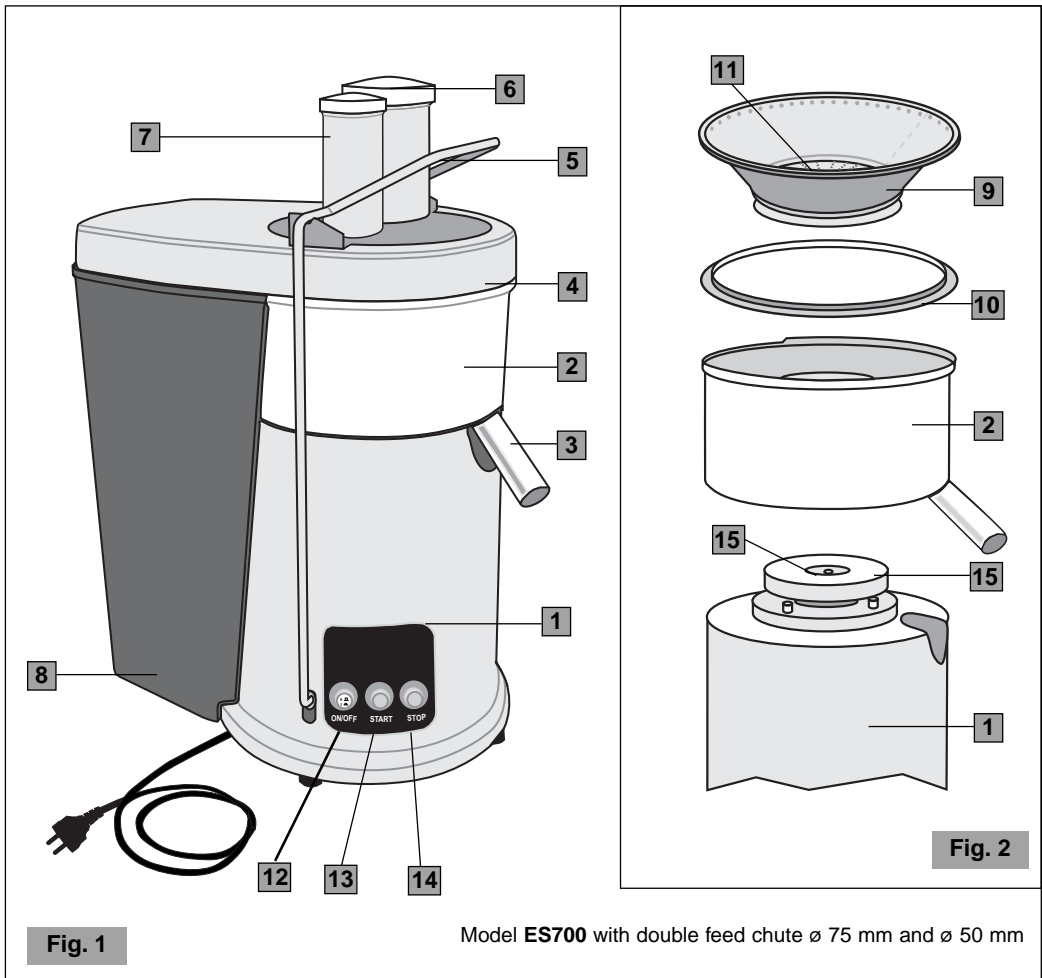

Model **ES500** with feed chute  $\varnothing$  75 mm

Fig. 3

Model **ES500S** with feed chute  $\varnothing$  50 mm

Fig. 4

## SAFETY RECOMMENDATIONS GENERAL INSTRUCTIONS

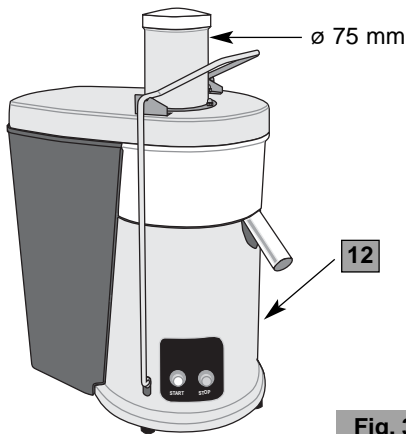
1. Read the following instructions carefully before using the appliance.
2. Installation and maintenance should be carried out by qualified personnel only.
3. This appliance is intended for professional use, and should therefore be used by adults and qualified personnel only.
4. This appliance is not meant for use by persons (including children) with reduced mental, sensorial or physical abilities or without experience and knowledge, unless they have been duly instructed on the use of such appliance and are supervised by a person responsible for their safety.

### CHILDREN SHOULD BE SUPERVISED SO AS TO ENSURE THAT THEY DO NOT PLAY WITH THE APPLIANCE

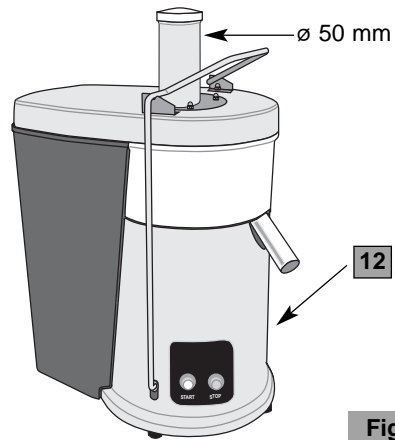
5. **Never** use this appliance for purposes other than extracting juice from pieces of fruit and vegetables. Any other use is dangerous.
6. Always work under safe conditions: do not use the appliance with wet hands or feet. **Do not use outdoors.**
7. Keep the original package for possible future use. It is the most suitable protection against damage during transport.
8. In case of fire use CO<sub>2</sub> extinguishers. Do not use water or powder extinguishers.
9. **Never** place the appliance in water!
10. Do not disassemble the appliance or attempt to perform any repairs inside it.

11. Always unplug the appliance before performing any maintenance or cleaning and when it is not in use.
12. **Never** pull the appliance by the cord to move it. **Never** unplug it by pulling the cord or touching it with wet hands.



**If the power cord is damaged, it must be replaced by the manufacturer or by its technical assistance service or, in any case, by someone having equivalent knowledge, so as to prevent any risk.**

13. **WARNING:** BE CAREFUL to never insert utensils, metal objects or other rigid or sharp materials in the basket as it is dangerous and could cause injury.
14. During maintenance procedures and while unpacking, do not hold or lift the appliance by the locking arm of the juicer cover.
15. When cleaning the appliance use care in handling the basket so you do not alter the alignment or reduce the performance of the appliance.
16. **Do not use the appliance if it is damaged or has loose parts. Immediately contact an authorized Service Center.**
17. **Do not** push fruit or vegetables into the feed chute with your fingers. Always use the food pusher provided.
18. **Do not** touch the sharp teeth of the grating disc.
19. **Do not** insert fruit with stones (e. g. peaches, apricots, etc.) without first removing the **stone**.
20. On model with two feed chutes **never insert** the  $\varnothing$  50 pusher in the  $\varnothing$  75 chute.
21. **Never** use the appliance if the rotating basket is damaged.



**WARNING: DO NOT PUT FINGERS OR ANYTHING OTHER THAN THE APPROPRIATE FOOD PUSHER PROVIDED WITH THE APPLIANCE INSIDE THE FEED CHUTE. ALWAYS USE THE FOOD PUSHER TO PUSH THE FRUIT TOWARDS THE ROTATING GRATING DISC.**

---

---

## INSTALLATION

Comply with the **safety recommendations** indicated above and hereafter when installing the appliance .

1. Make sure that the mains voltage is as indicated on the rating label of the appliance and that the electrical system is grounded and equipped with a switch.
2. Install the appliance in a **DRY, PROTECTED place**, far from water sprays or splashes, heat sources, open flames and inflammable substances.  
Place the appliance on a **flat, horizontal, stable surface** where it cannot tip over.
3. Make sure the switch on the appliance is in the "OFF" position and plug it into a socket protected by a suitably rated circuit breaker (MCB) or fuses.  
**Do not use an adaptor plug.**
4. Stretch the power cable out to full length. **Do not** let it pass over sharp edges or hot surfaces. **Do not** let oil spill on it. **Do not** let the power cable hang loose from the counter on which the appliance stands.
5. To use the appliance more easily, we suggest that the appliance is placed on a table or counter top so that the juice spout and the controls face towards the right side of the user (suggested height for counter top from a round level: 90 cm (36 inches), to be adjusted according to the height of the user).

---

## USE



Make sure the tabletop and feet are clean to ensure grip during operation.



**Before first use:** rinse all of the parts that will have contact with food in running water i.e.; food pusher, juicer cover, basket, bowl, pulp container and pulp retainer. To disassemble the various parts see Fig. 8 and Fig. 9.



**Suggestions:** to reduce the cleaning procedures to a minimum we suggest placing a biodegradable plastic bag inside the pulp container and folding the top of the bag over the edge of the pulp container (see Fig. 5). By using this method, once you have finished using the appliance, you can put the waste directly into a composting or waste bin.

- 1** Wash the fruit or vegetables you will use.

**NOTE:** Many types of fruit and vegetables for example apples, carrots and cucumbers fit through the feed chute without having to be cut into pieces. When you make juice from carrots it is a good idea to insert the larger end of the carrot first, or to cut the carrot in two or three pieces.

For models with feed chute  $\varnothing$  50 mm, use the latter to juice carrots. To optimize the juice output chop fruit into smaller pieces.

- 2** Ensure that the juice extractor is correctly assembled. Ensure that the basket is properly cleaned before each use.
  - 3** Check to see that the ON-OFF button is in the "OFF" position and that the locking arm is hooked on to the juicer cover.
-

- 4 Place a container under the spout of the bowl.
- 5 Turn the appliance on by pushing the ON-OFF button in the "ON" position.
- 6 Turn on the motor by pushing the START button.
- 7 With the motor in action put fruit and/or vegetables in the feed chute. Use the food pusher to gradually push down the fruit and/or vegetables towards the spinning grating disc at the bottom of the feed chute without exerting excessive pressure (see Fig. 6). To obtain more juice always press the food pusher lightly.

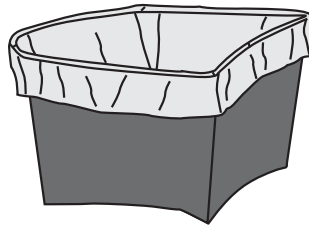

Fig. 5

**!** NEVER USE YOUR FINGERS TO PUSH THE FRUIT AND/OR VEGETABLES DOWN THE FEED CHUTE OR TO CLEAN THE CHUTE. ALWAYS USE THE FOOD PUSHER PROVIDED.

- 8 The juice will pour from the spout into the container placed below the spout. The separated pulp will accumulate in the pulp container.
- 9 Continue to use the appliance until the container is filled with juice or until you have finished the fruit or vegetables you are using or ensure the pulp container has become filled with pulp.
- 10 Turn the motor off by pushing the STOP button.

**Note:** Always wait until the motor has come to a complete stop before unhooking the locking arm.

**!** Never use the locking arm to turn the appliance off. This could wear out the safety mechanisms (safety microswitch and motor brake).

- 11 When the appliance is not in use leave the locking arm hooked to the juicer cover and the ON-OFF button in the "OFF" position.

**!** When using the appliance control the level of pulp in the pulp container (with the motor turned off). The quantity of fruit or vegetables that can be used before the pulp container is filled varies depending on the type of fruit or vegetables used.

**!** Should blockage occur while the appliance is in use before the pulp container is filled with pulp it is a good idea to turn the appliance off and find the cause of the blockage.

**NOTE!** When using the juice extractor the pulp container can be emptied by turning the appliance off and carefully removing the pulp container. (Put the pulp container in place before turning the juice extractor back on).

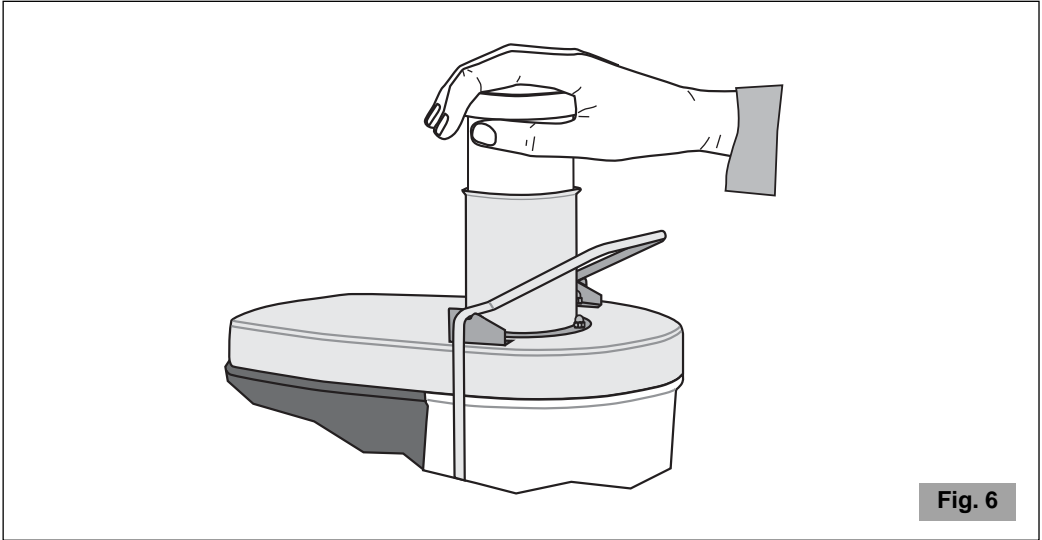

Fig. 6

## CLEANING AND MAINTENANCE

**Suggestions:** to reduce the cleaning procedures to a minimum we suggest placing a biodegradable plastic bag inside the pulp container, folding the top of the bag over the edge of the pulp container (see Fig. 5). By using this method, once you have finished using the appliance, you can put the waste directly in a composting or waste bin.



**Before each cleaning turn the appliance OFF and remove the appliance's plug.**

By keeping the appliance well-cleaned and in working order you can maximize the quality of the juice extracted and guarantee a longer life for the appliance itself. For this reason, after every use, you should clean the basket, bowl, juicer cover, pulp container, pulp retainer, and food pusher so that residues do not harden and encrust the appliance.



**To clean the motor housing**, clean with a cloth dampened with water or alcohol or with a spray neutral solution.

Wipe with a dry cloth.



**Never put the motor housing under running water and never immerse the appliance in water.**



**To clean the juicer cover, bowl, basket, pulp container\*, pulp retainer and food pusher:** rinse under running water and wash with warm water and washing liquid. Rinse and dry.

To disassemble these components, unhook the locking arm and remove in this order; food pusher, juicer cover, basket, pulp retainer, and bowl (Fig. 8). Reassemble in the reverse order taking care to place the juice spout in the appropriate slot of the motor housing, **place the pulp retainer in its correct place with the internal edge facing up** (Fig. 8), place the basket in the bowl, making sure that the basket's clutch disc is correctly inserted on the drive disc and position the juicer cover on the bowl.

- The removable parts of the juice extractor, with the exception of the pulp container, are dishwasher safe. The pulp container should not be immersed in hot water. Hot water can deform the pulp container making it impossible to use.
- To obtain a higher yield of juice always control that the basket is well-cleaned by using the nylon brush provided. Put the basket under running water and use the brush to clean the inside of the strainer (see Fig. 7). Hold the basket up against the light to make sure that none of the perforations are blocked. Should the perforations of the strainer remain blocked, immerse the basket in a solution of hot water with 12% lemon juice or vinegar to loosen the blocked material. Alternatively, wash the basket in a dishwasher.
- Handle the basket with care as even the slightest damage to the pulp container can cause the juice extractor to vibrate undesirably during use.

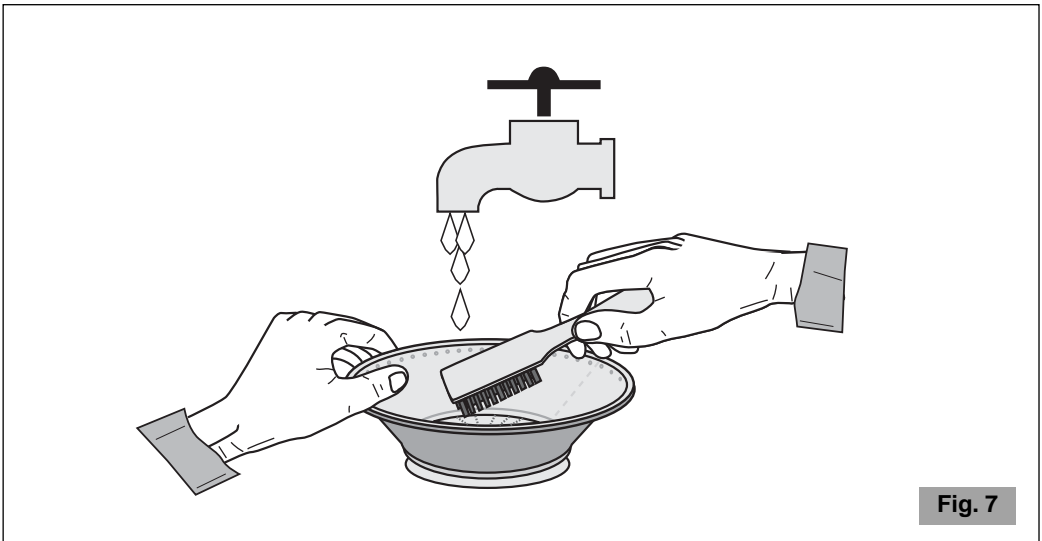

Fig. 7

As some products (such as peeled citrus fruits, celery and tomatoes) can easily encrust or obstruct the perforations, you should frequently clean the basket.

- ⚠ **THE BASKET HAS SMALL SHARP TEETH. DO NOT TOUCH THE TEETH WHEN YOU HANDLE THE BASKET.**
- ⚠ **Do not use abrasive products or sponges to clean the basket.**
- ⚠ **Do not let traces of fruit or vegetables dry and harden on the pulp container, basket, juicer cover or food pusher.**
- ⚠ **Never use bleach or chlorine-based cleaning products on the juice extractor.**



- **For a periodic deep-cleaning** you can disassemble the parts of the basket by unscrewing the nut under the basket (Fig. 9).

**To disassemble the parts of the basket**, hold the basket still with one hand and unscrew the nut with a pipe wrench number 13 (Fig. 9). Pull the screw out of the basket.

Wash all of the parts in warm water with dish soap, removing any residues with the brush provided.

Reassemble in reverse order (Fig. 9) and make sure that the base of the basket is mounted with the outer edge turned down. **To reassemble the parts of the basket** tighten the screw to the nut with a pipe wrench number 13. Ensure that the parts are tightly attached to one another.

---

## INFORMATION ON FRUIT AND VEGETABLE JUICES

Freshly-made juices should be consumed immediately following their extraction to obtain maximum vitamin content.

### PURCHASE AND STORAGE OF FRUIT AND VEGETABLES

- Always wash fruit and vegetables before juicing.
- Always use fresh produce.
- To save money and obtain higher-quality juices, always use fruit and vegetables that are in season.
- Always keep produce ready to juice by washing it before putting it in the refrigerator.
- Most fruit and vegetables can be kept at room temperature. Delicate fruit and vegetables, such as tomatoes, berries, lettuce, celery, cucumbers and herbs should be kept in the refrigerator until use.
- Do not use overly ripe fruit because it clogs the basket very quickly.

### PREPARATION OF FRUIT AND VEGETABLES

- Fruit or vegetables with a hard or inedible skin or rind, such as melon, pineapple, mango, kiwi, etc., must be peeled before being inserted in the juice extractor.
- All citrus fruits must be peeled before being inserted in the juice extractor.
- Remove the stones from fruits such as peaches, apricots, plums, etc., before inserting the fruit in the juice extractor.
- A small quantity of lemon juice can be added to apple juice to prevent discoloration.

**Suggestions:** the juice extractor also gives a high yield of juice from oranges. Remember to always peel oranges and all citrus fruits before inserting them in the juice extractor (we also suggest putting the oranges in the refrigerator before use).

---

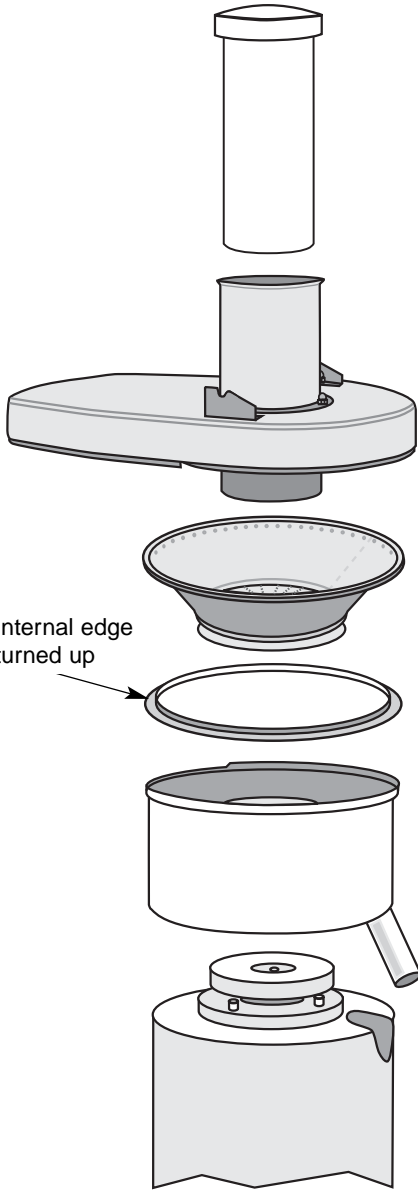

Fig. 8

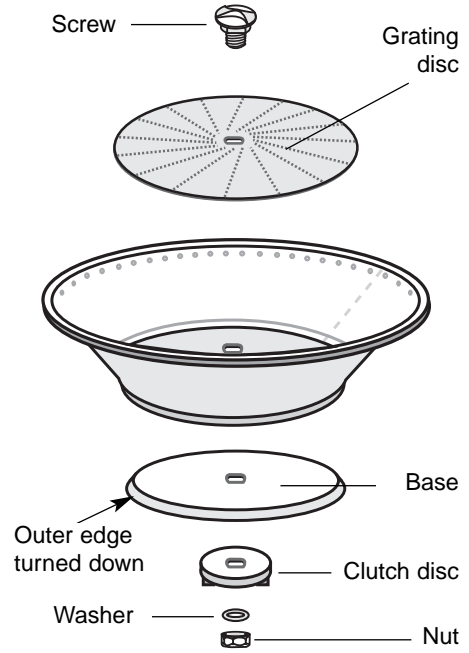

Fig. 9

## RECOMMENDATIONS FOR PROPER USE

When you make juice from different types of ingredients with different consistencies it is a good idea to start with the softer ingredients and then subsequently use the harder ingredients.

When you make juice from herbs or lettuce you should press them together to form compact balls, or mix them together with other ingredients to obtain a better result.

**NOTE! Herbs and lettuce give a low yield of juice. This is due to the characteristics of the produce and of the juice extractor. It is therefore advisable to always make juice from herbs and lettuce mixed together with other fruit or vegetables.**

Different types of fruit and vegetables yield different quantities of juice. The amount of juice varies even between fruit and vegetables of the same kind, for example two apples of the same variety and with the same weight can produce different quantities of juice. Given the fact that juice recipes are not an exact science, using precise quantities of ingredients for each juice recipe is not a determining factor for the successful outcome of the recipe.

**NOTE! To obtain a high yield of juice always press the food pusher lightly.**

---

## TROUBLESHOOTING

(See Table on the next page)

In case of any malfunction, defect of the appliance or if you suspect any breakage after a fall, unplug the appliance immediately.

If you are unable to solve the problem referring to the table below, contact an Authorized Service Centre.

**Only qualified experts should repair the appliance.**

We are not liable for any damage caused by repairs not made correctly and/or by unauthorized personnel. In these cases the warranty does not apply.

---

---

Problem	Solution
The appliance does not turn on.	<ul style="list-style-type: none"> <li>• Make sure the feed chute is empty.</li> <li>• Make sure it is plugged in.</li> <li>• Make sure the safety circuit breaker is closed.</li> <li>• Make sure the locking arm is correctly hooked onto the juicer cover.</li> <li>• Make sure the start button on the appliance is turned ON.</li> <li>• If the problem occurs itself after a long period of intensive use or overfilling, the motor could be in thermal protection lock! Wait at least 20 minutes and try again. The waiting time can be reduced by putting the appliance in a cool place.</li> </ul>
The appliance vibrates in an abnormal manner.	<ul style="list-style-type: none"> <li>• The vibration can be caused by: <ul style="list-style-type: none"> <li>• Incorrect positioning of the basket. Check alignment.</li> <li>• Deterioration of the structural components of the basket. Check and replace if necessary.</li> <li>• Accumulation of pulp in the basket. Check and empty pulp if necessary.</li> <li>• Full container.</li> </ul> </li> </ul>
Juice does not come out of the spout.	<ul style="list-style-type: none"> <li>• Blockage of the basket. Check and clean the basket.</li> <li>• The opening of the spout is blocked. Check and clean the bowl and spout.</li> <li>• Use of fruit that has too much pulp or is too ripe. Check and clean the bowl and basket.</li> </ul>
Excessive accumulation of pulp in the basket.	<ul style="list-style-type: none"> <li>• Try to alternate between soft and hard fruits when using the juice extractor.</li> </ul>
Pulp appears excessively wet and a low quantity of juice is produced.	<ul style="list-style-type: none"> <li>• Try to insert the fruit or vegetables more slowly and with less force.</li> <li>• Make sure that the basket is always carefully cleaned with the nylon brush provided. Put the basket under running water and use the brush to clean the inside of the strainer (see Fig. 7), holding the basket up against the light to make sure that none of the perforations are blocked. Should the perforations of the strainer remained blocked, immerse the basket in a solution of hot water with 12% lemon juice or vinegar to loosen the material that blocked them. Alternatively, wash the basket in a dishwasher.</li> <li>• Fruit too ripe.</li> </ul>

## DISPOSAL

### Correct disposal of this product (waste electrical and electronic equipment)

(Applicable in the European Union and other countries with separate collection systems in conformity with European Directive 2002/96/EC)

This product has been made from high-quality parts and materials, which can be re-used and recycled.

Therefore, do not throw the product away with normal household waste at the end of its working life. Take it to a collection point for recycling electrical and electronic devices. This is indicated by this symbol on the product and in the operating manual.

Please contact your local government office for information about the exact location of the closer collection point.

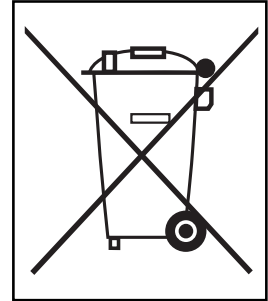

---

## WARRANTY

This product has been manufactured to a high quality standard.

This product is guaranteed against faulty materials and workmanship for a period of two years from the date of purchase when it is used according to the instructions in this instruction and maintenance manual.

Please retain any receipt as proof of purchase.

During the warranty period, this product can either be repaired or replaced, at the manufacturer's discretion, at no additional cost.

If the product needs maintenance or repairs during the warranty period, contact your retailer for shipping instructions. The product should be shipped in its original package or other suitable packing.

The warranty does not apply in case of neglect, misuse, abuse or unauthorized repairs. This warranty does not apply to parts subject to deterioration through normal use such as wear to the basket, the grating disc, etc. This warranty does not apply to damage caused by foreign objects, substances or accident.

The warranty is limited to the costs of repair or replacement of the product or its defective parts, or an amount equivalent to the price paid for its purchase. No additional requests of damages will be available to the purchaser.

This guarantee is in addition to and does not affect your statutory rights.

---

The manufacturer will not accept any liability and the warranty will be invalidated if there is a failure to follow these instructions and the technical and/or safety standards in the country where the appliance is to be used.

In any case these instructions cannot cover every possible event and the user is recommended to use the appliance responsibly.

---

**THE MANUFACTURER RESERVES THE RIGHT TO MAKE ANY ALTERATIONS TO THE APPLIANCE WITHOUT NOTICE**

---

